

T-195 Interstage MonoBlock Wiring Diagram MASTER

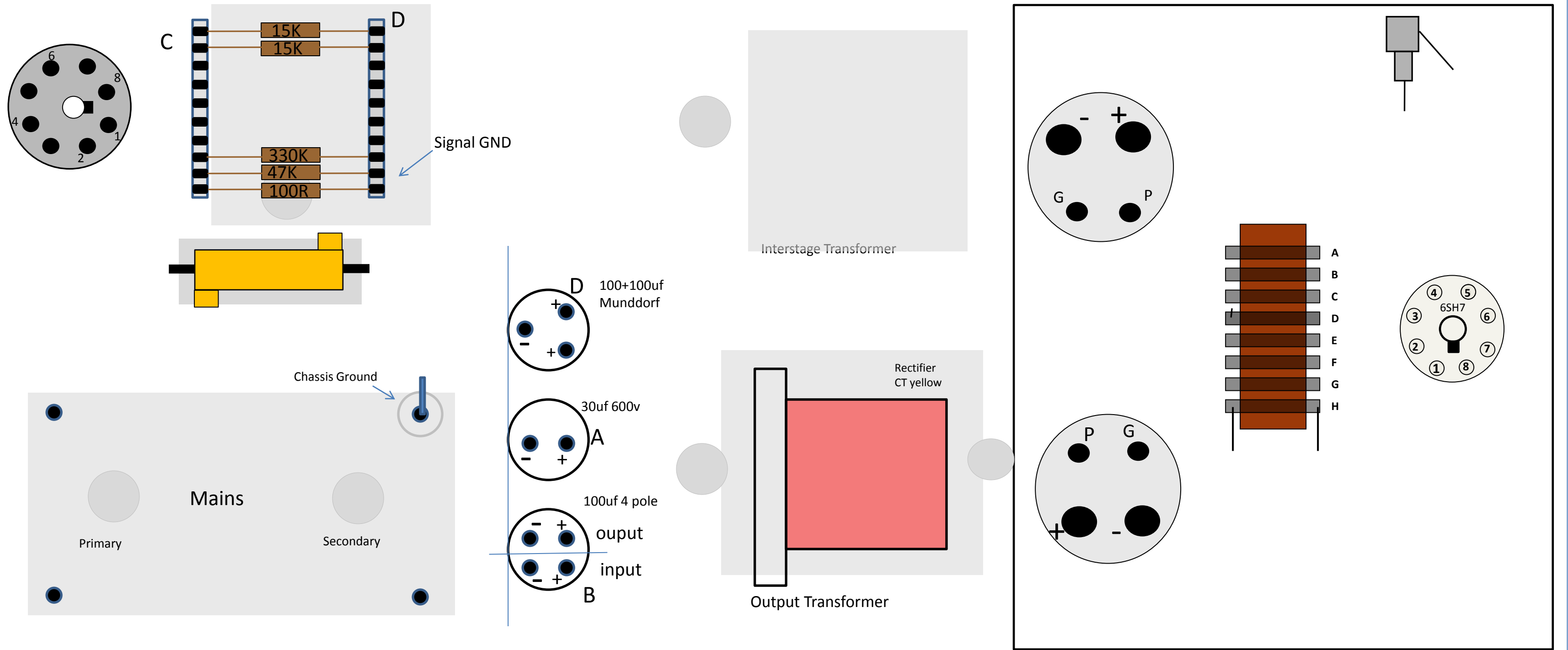

T-195 Mains Interstage MonoBlock Wiring Diagram – Rectifier Wiring & Chassis GND

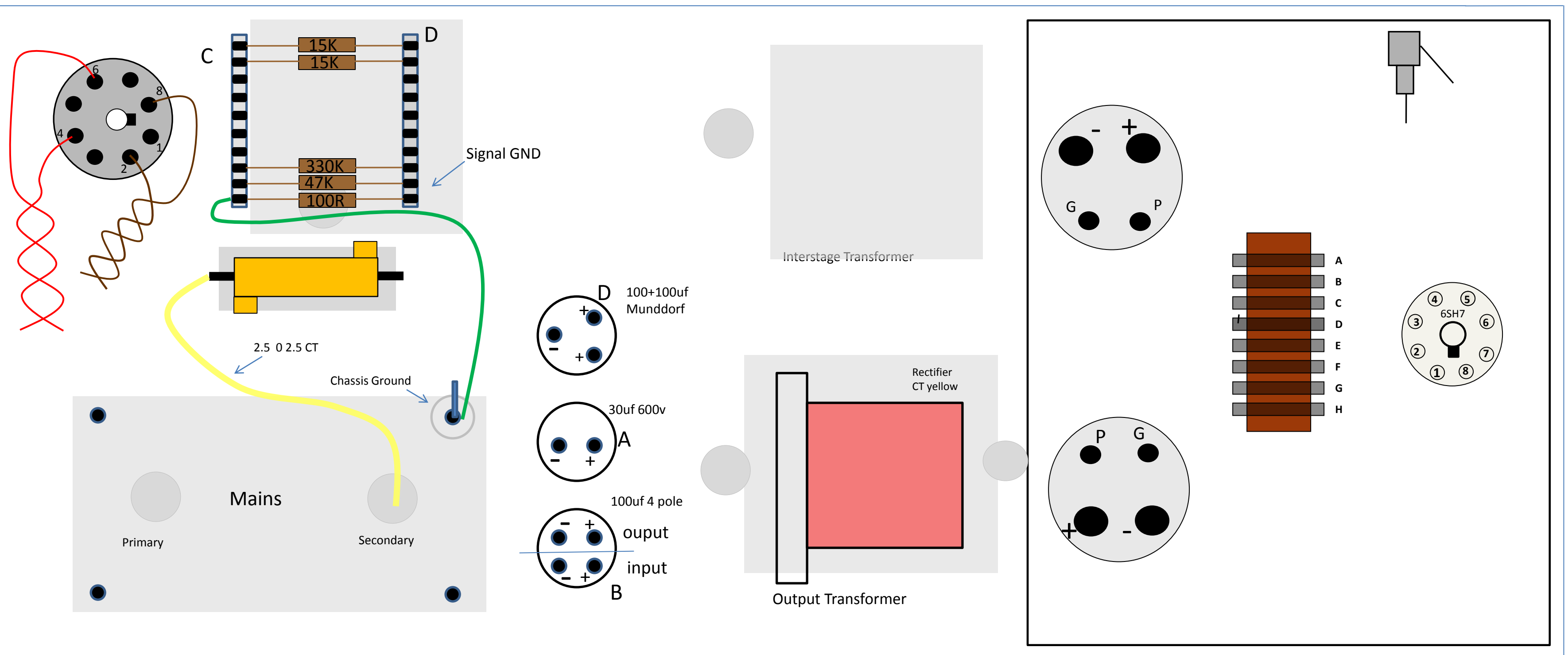

T-195 Mains Interstage MonoBlock Wiring Diagram – Signal GND

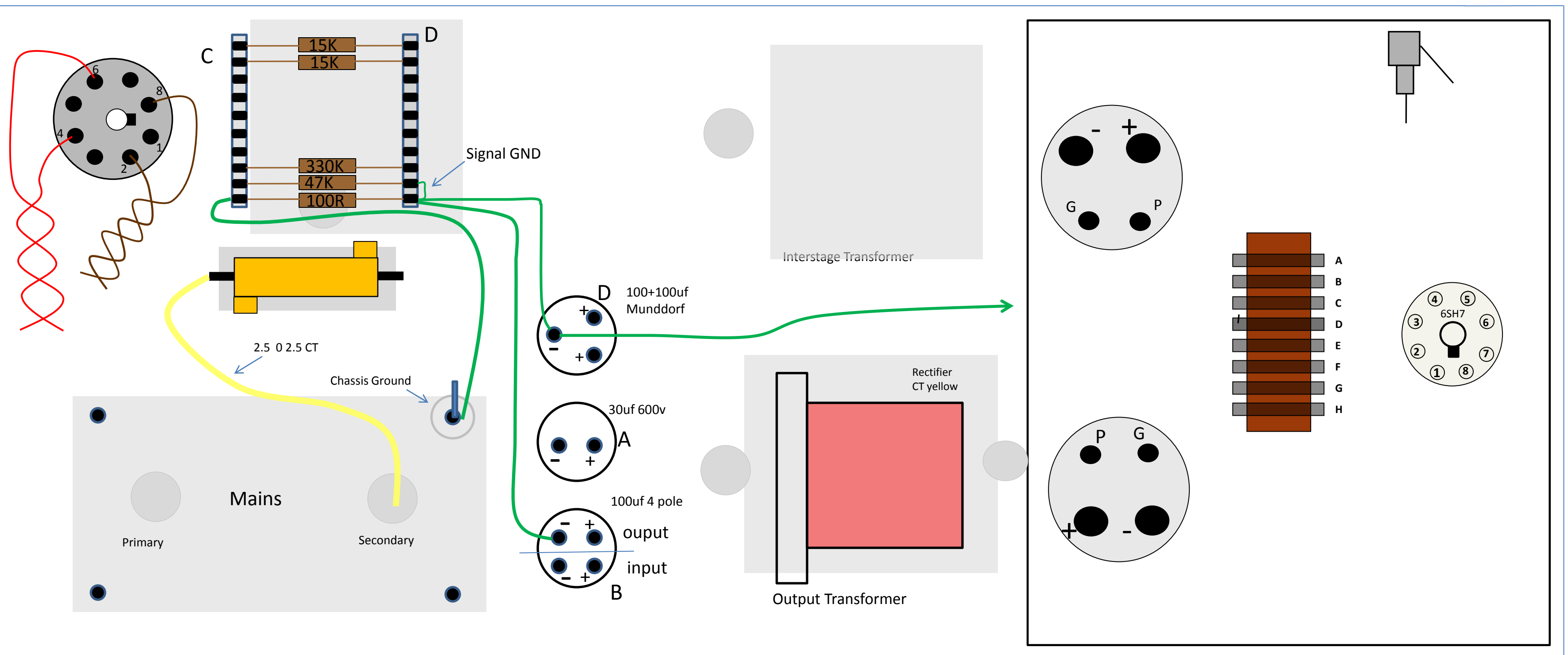

T-195 Mains Interstage MonoBlock Wiring Diagram – 4 pole cap GND to 30uf cap!

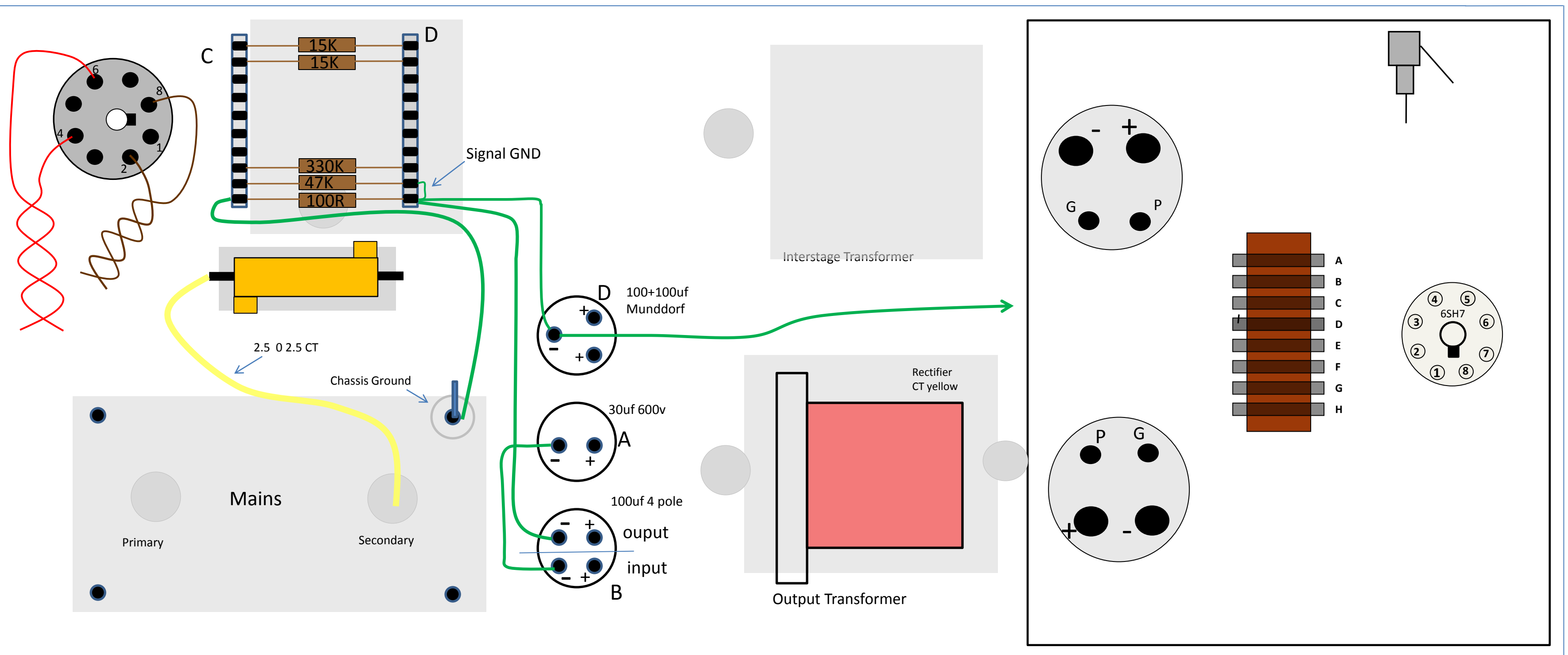

T-195 Mains Interstage MonoBlock Wiring Diagram –

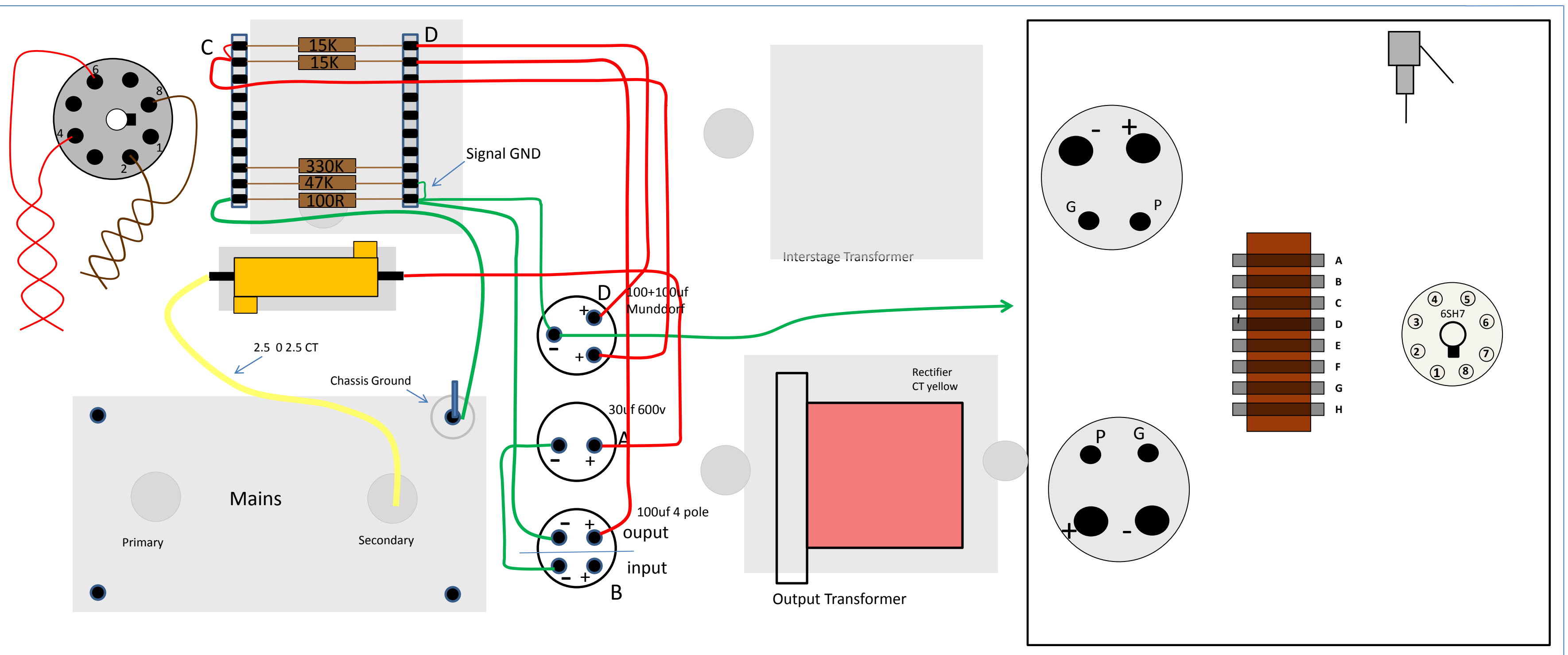

T-195 Mains Interstage MonoBlock Wiring Diagram – CHOKE Connections to A & B

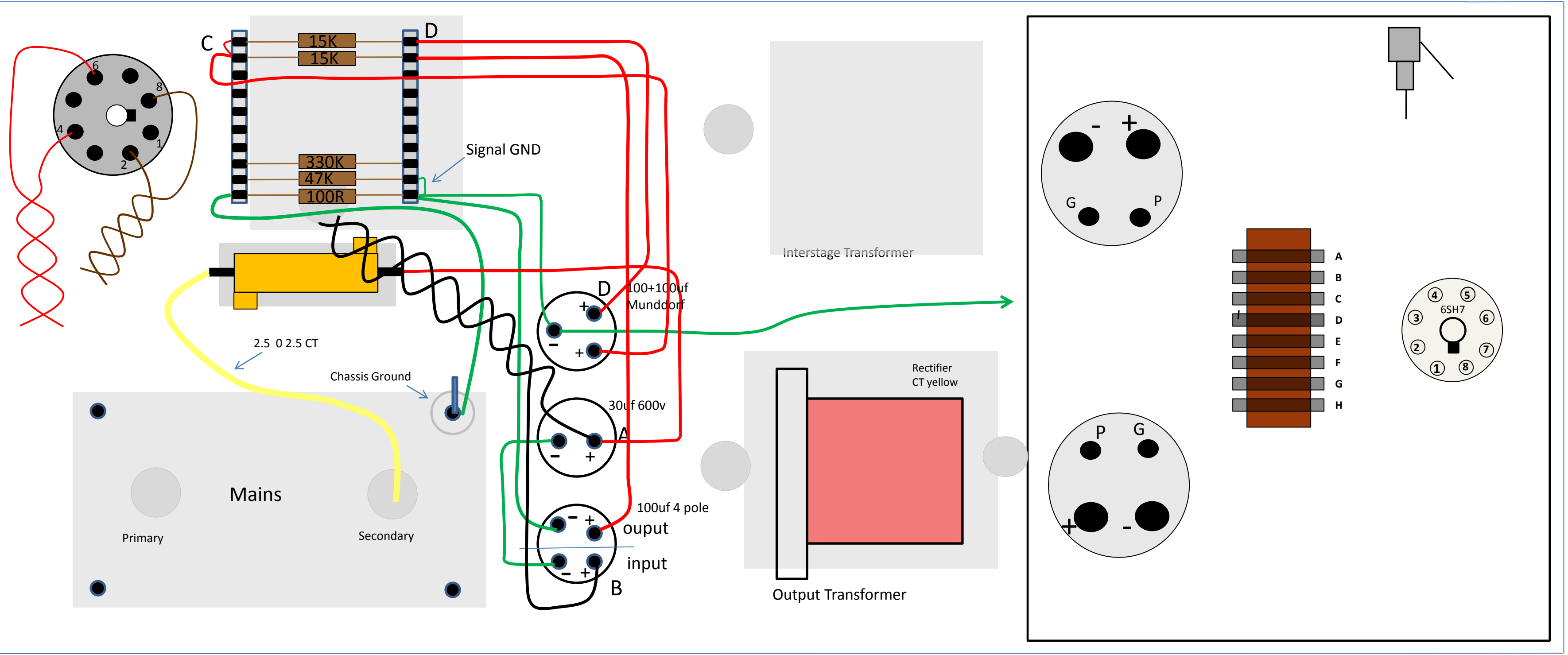

T-195 Mains Interstage MonoBlock Wiring Diagram – Interstage Black Wire to D

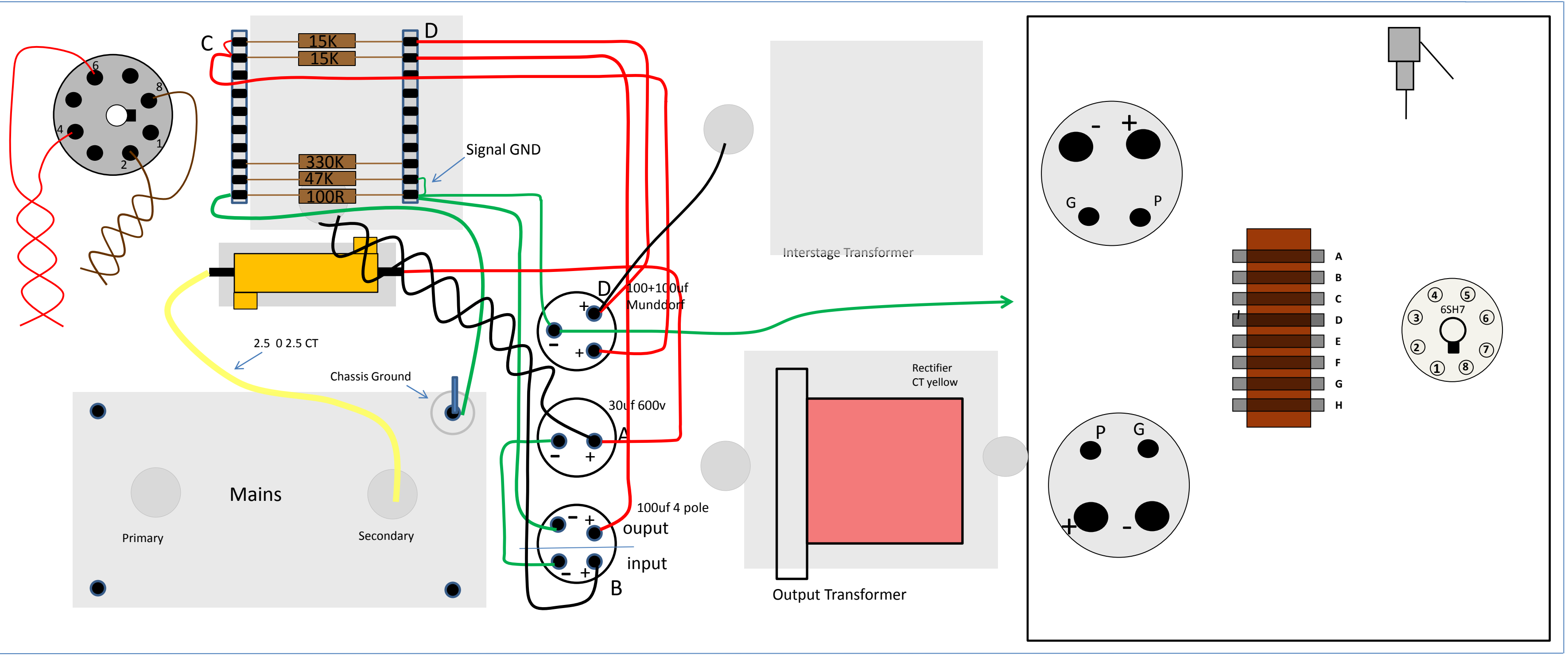

T-195 Mains Interstage MonoBlock Wiring Diagram – Interstage Black Wire to D

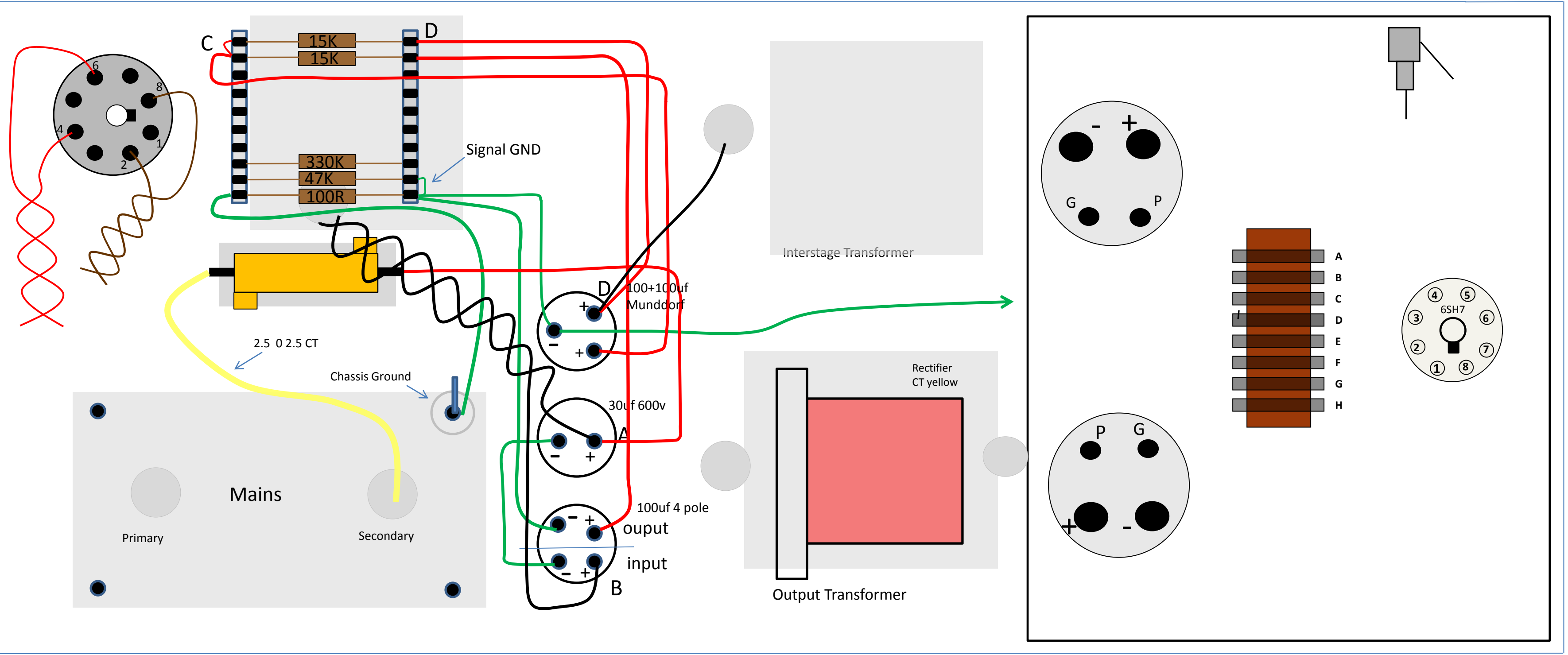

Front Insert Plate Wiring

This slide shows the TAG strip on the front insert plate and the connection that will be made to each tag

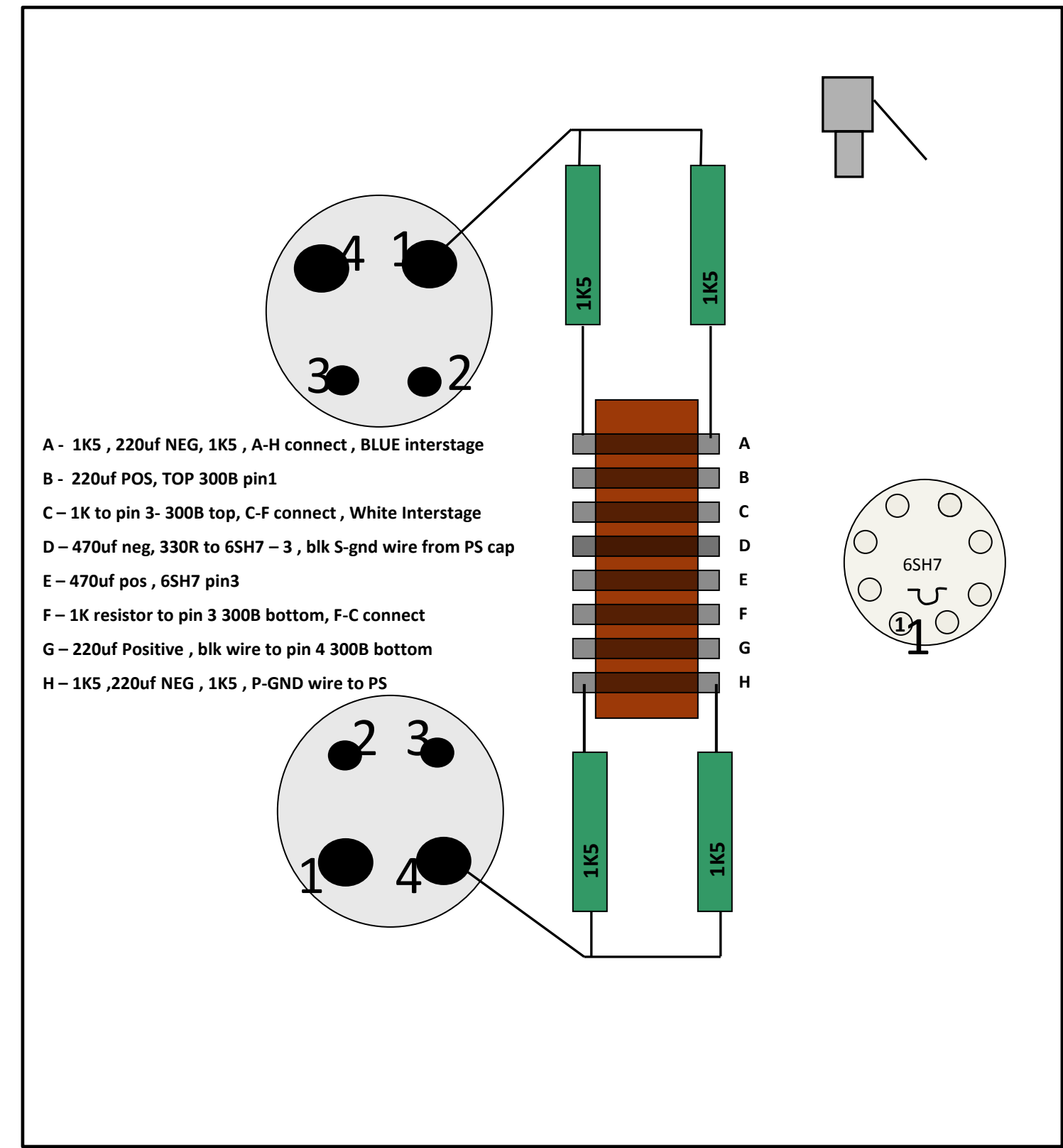

Front Insert Plate Wiring

For clarity purposes the following slides show the insert plate on the LEFT (preceding page graphic) on the right you can follow along as we build up the insert plate with each slide – this way you can refer back to the left drawing to check that the correct connections are being made.

4 x 1K5 resistor 10W
 2 x 220uf 100V capacitor
 1 x 470uf 16v capacitor

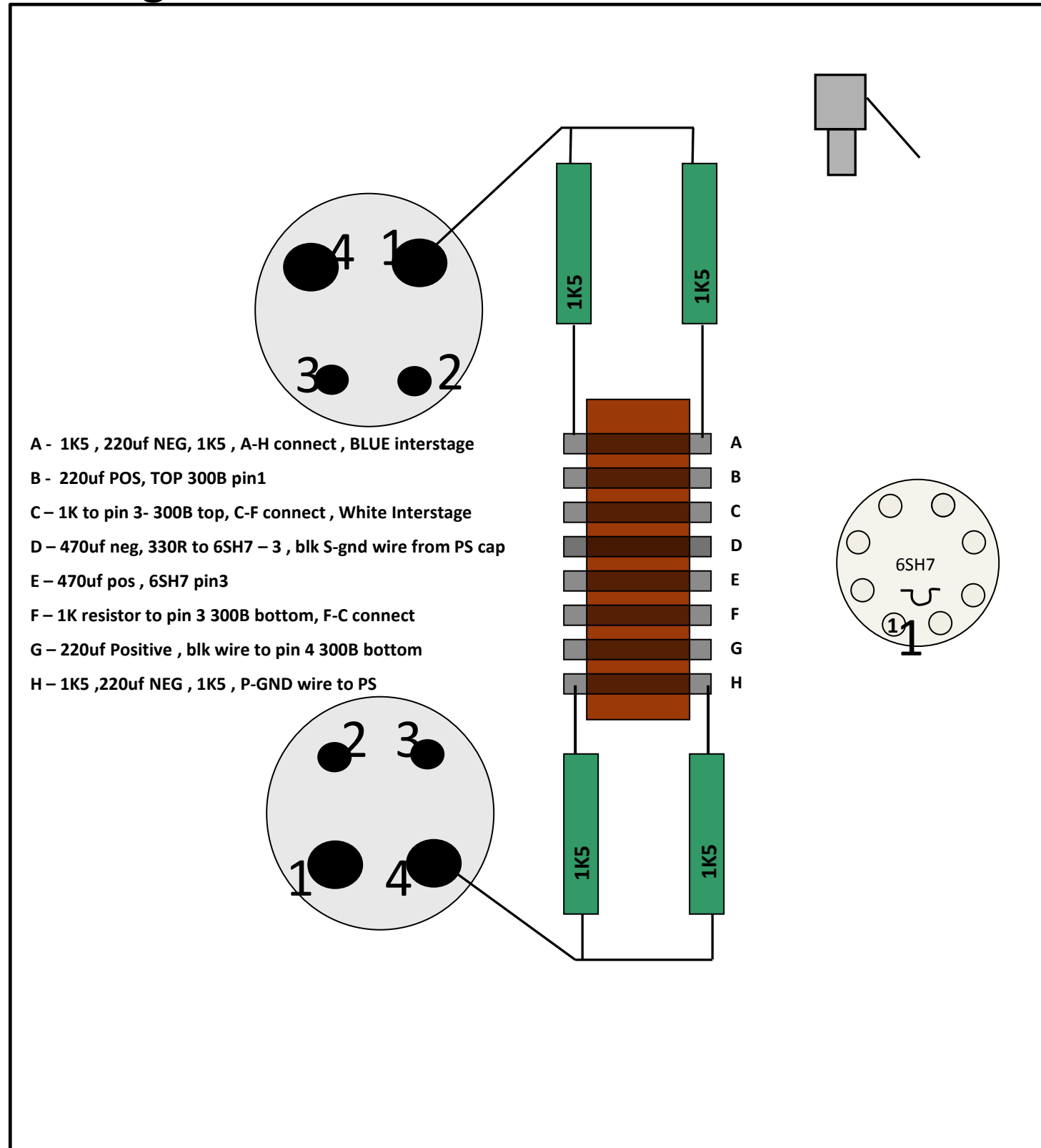

Capacitors & inter connections

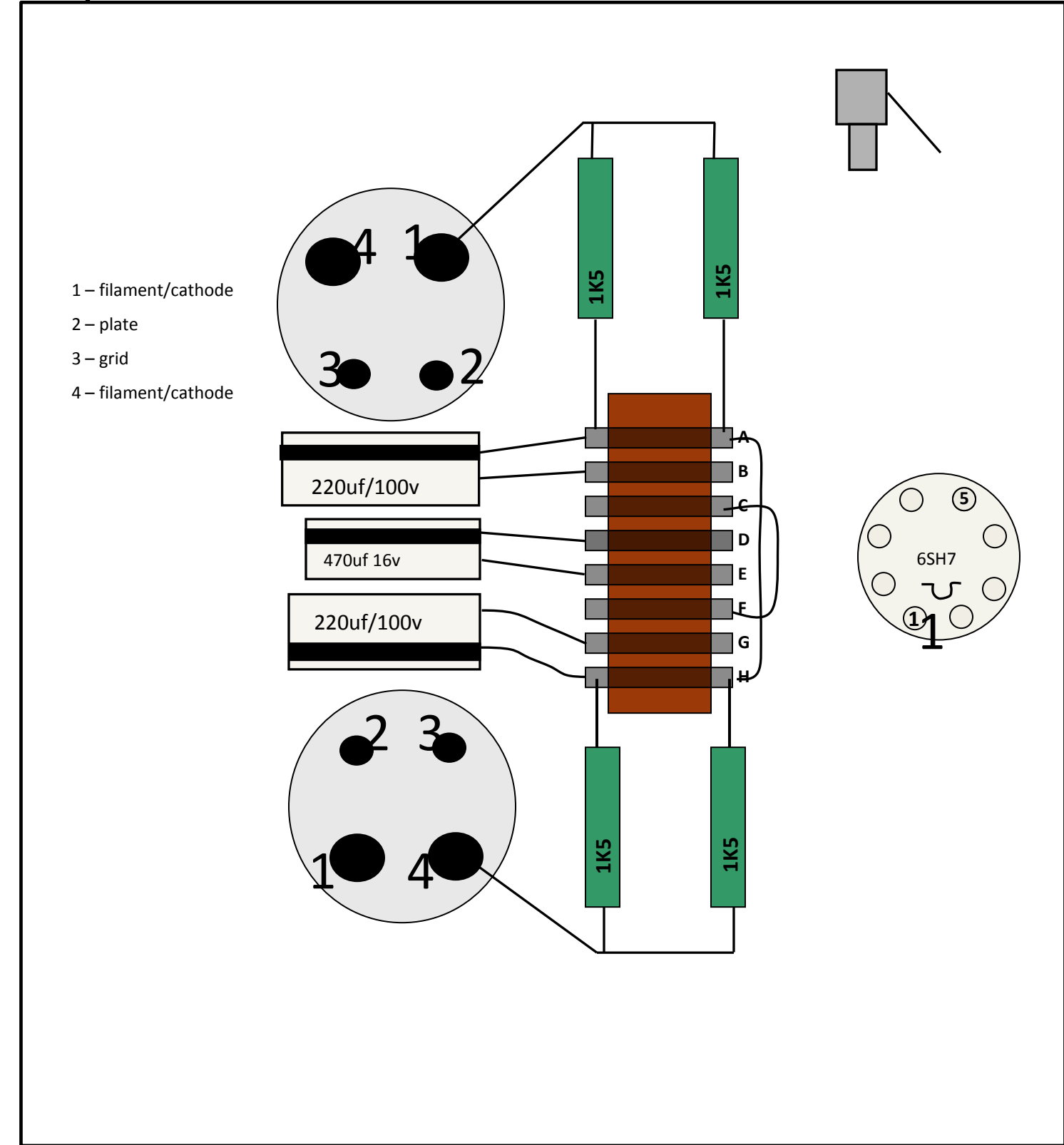

Front Insert Plate Wiring

For clarity purposes the following slides show the insert plate on the LEFT (preceding page graphic) on the right you can follow along as we build up the insert plate with each slide – this way you can refer back to the left drawing to check that the correct connections are being made.

4 x 1K5 resistor 10W

2 x 220uf 100V capacitor

1 x 470uf 16v capacitor

3 x 1K

1 x 330R

1 x 100R

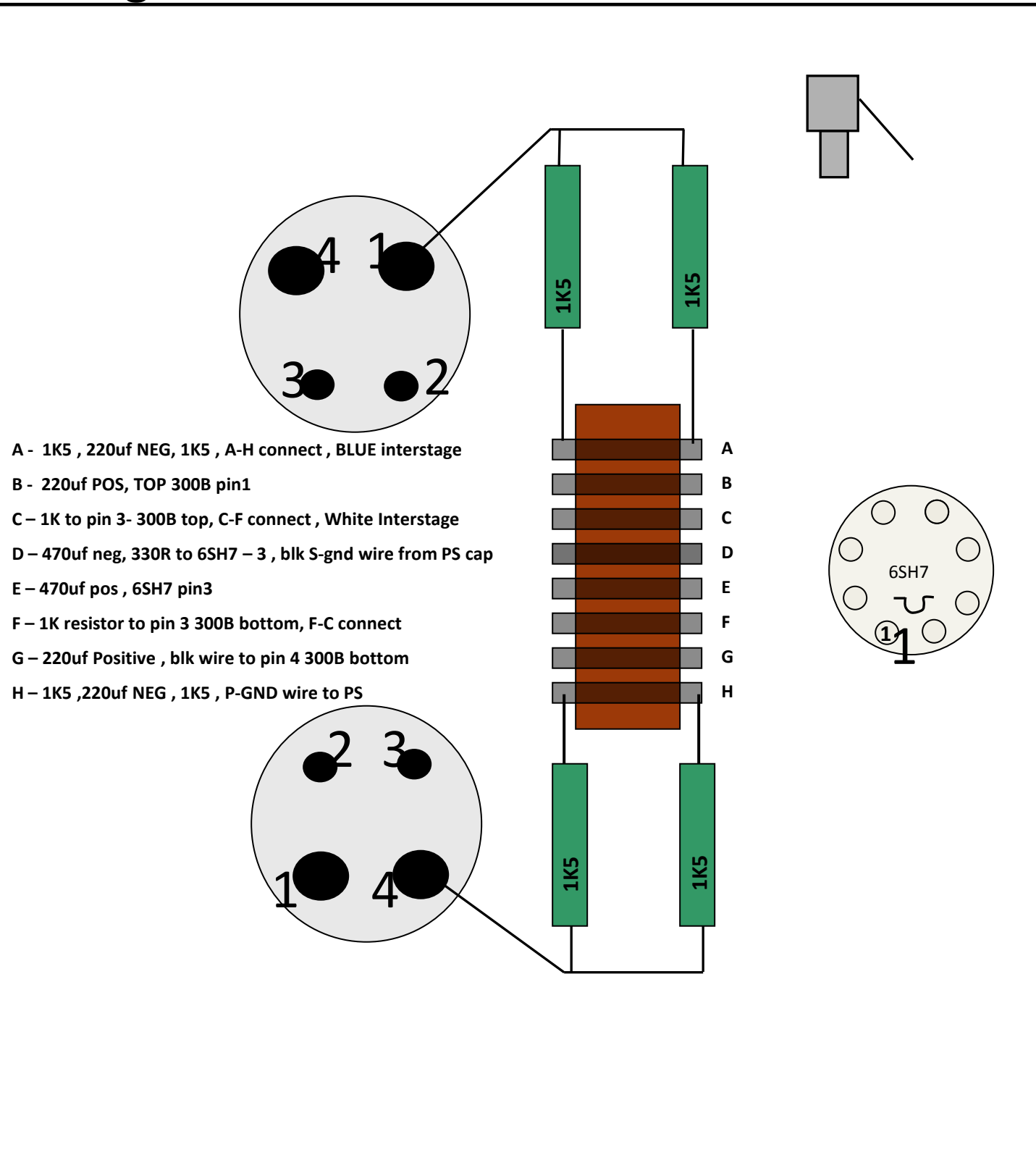

Resistors

1 - filament/cathode

2 - plate

3 - grid

4 - filament/cathode

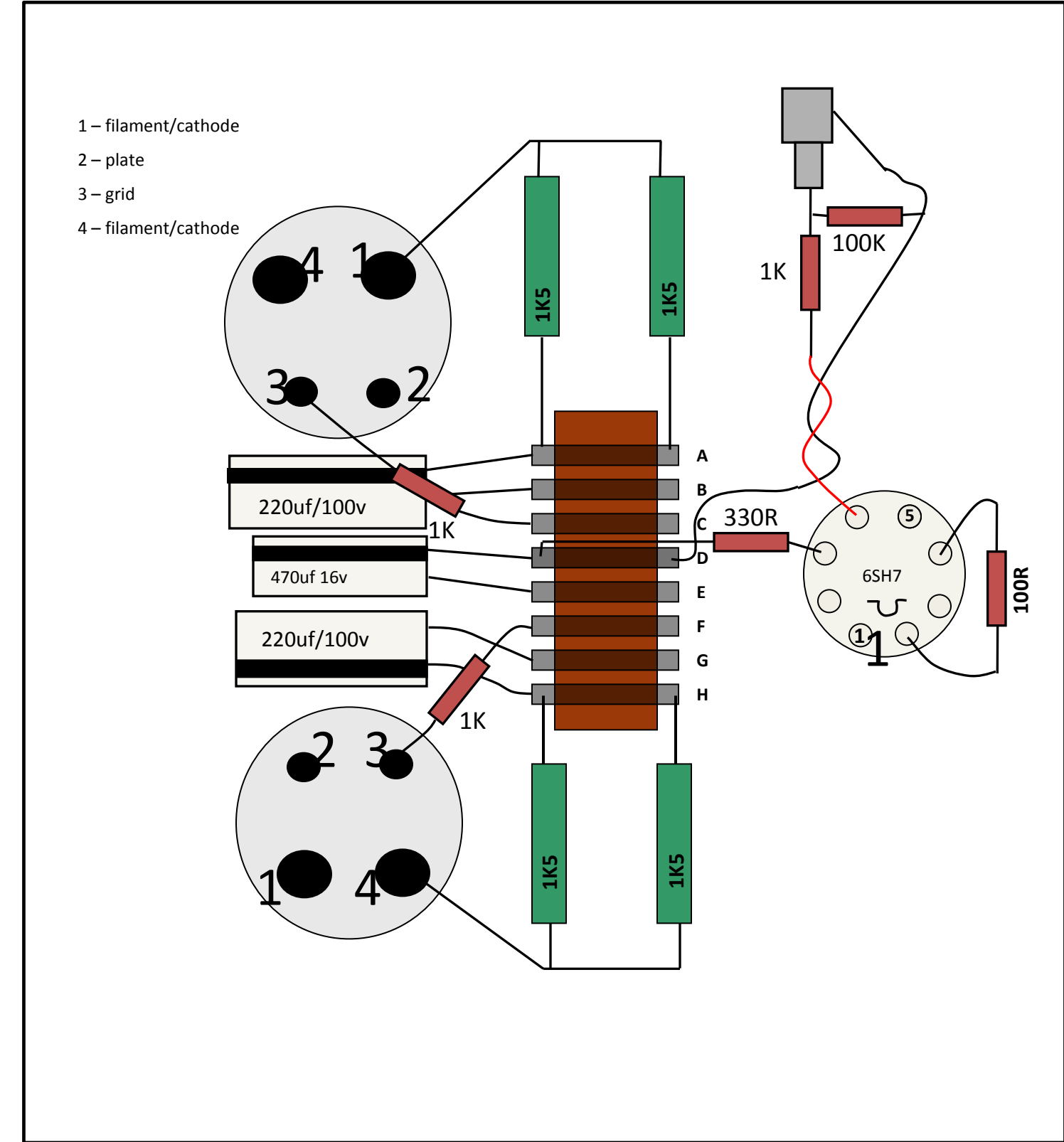

Front Insert Plate Wiring

For clarity purposes the following slides show the insert plate on the LEFT (preceding page graphic) on the right you can follow along as we build up the insert plate with each slide – this way you can refer back to the left drawing to check that the correct connections are being made.

4 x 1K5 resistor 10W

2 x 220uf 100V capacitor

1 x 470uf 16v capacitor

3 x 1K

1 x 330R

1 x 100R

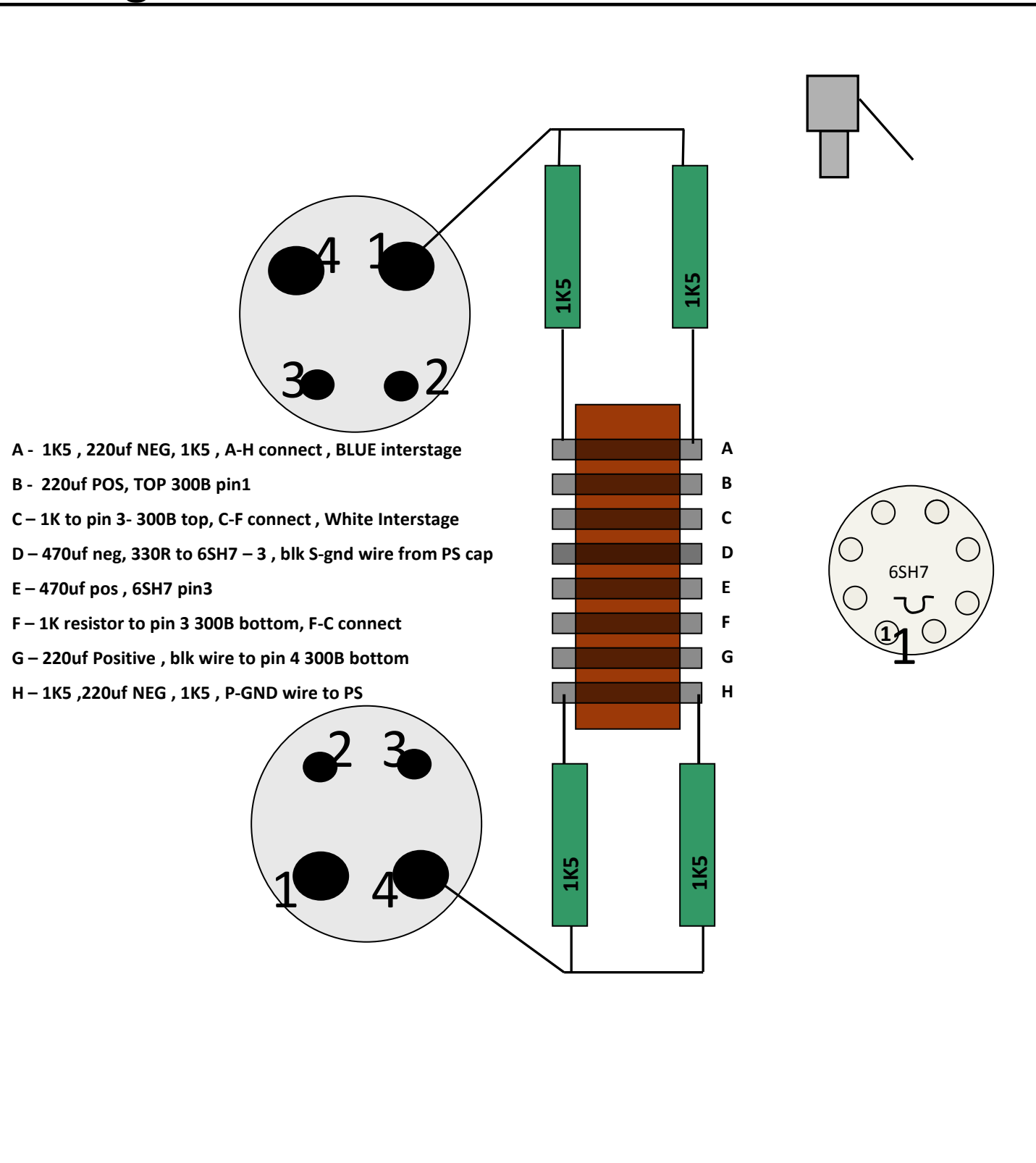

Resistors

1 - filament/cathode

2 - plate

3 - grid

4 - filament/cathode

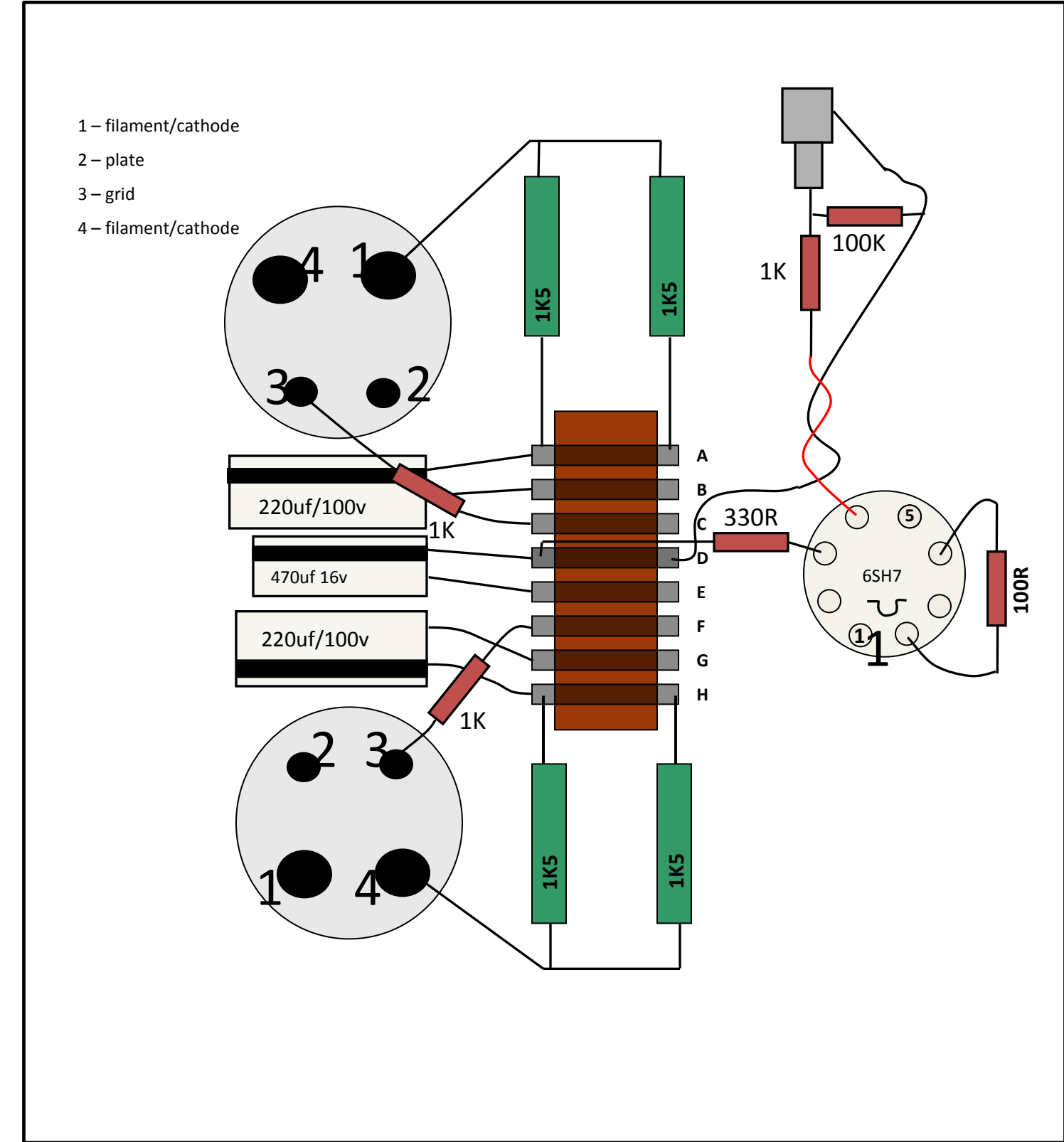

Front Insert Plate Wiring

For clarity purposes the following slides show the insert plate on the LEFT (preceding page graphic) on the right you can follow along as we build up the insert plate with each slide – this way you can refer back to the left drawing to check that the correct connections are being made.

4 x 1K5 resistor 10W

2 x 220uf 100V capacitor

1 x 470uf 16v capacitor

3 x 1K

1 x 330R

1 x 100R

A > > H connection

C >> F connection

E >> pin3 6SH7

O/P transformer red wire to Pin 2

Pin 2 >> pin 2 300Bs

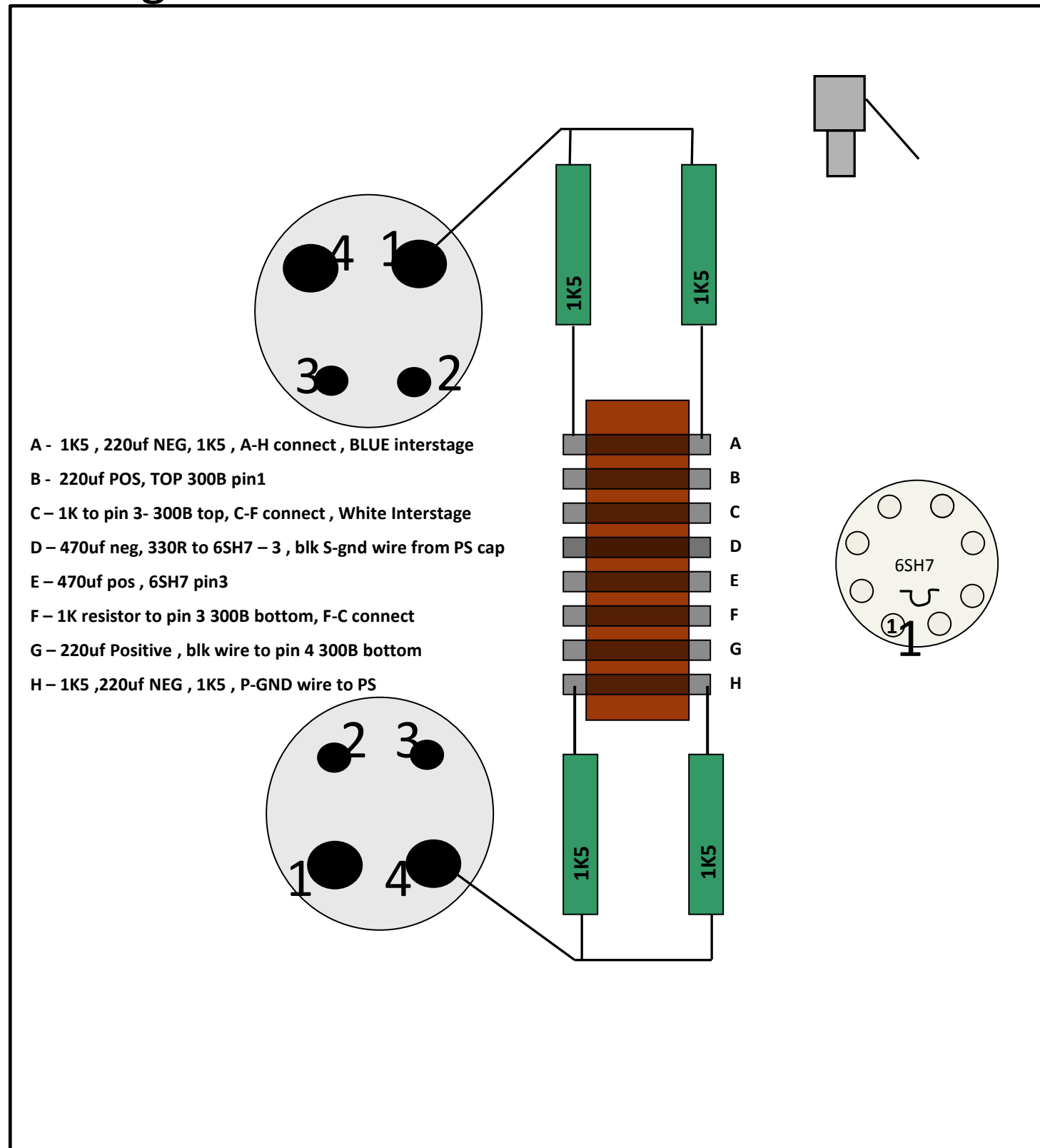

InterWiring Connections

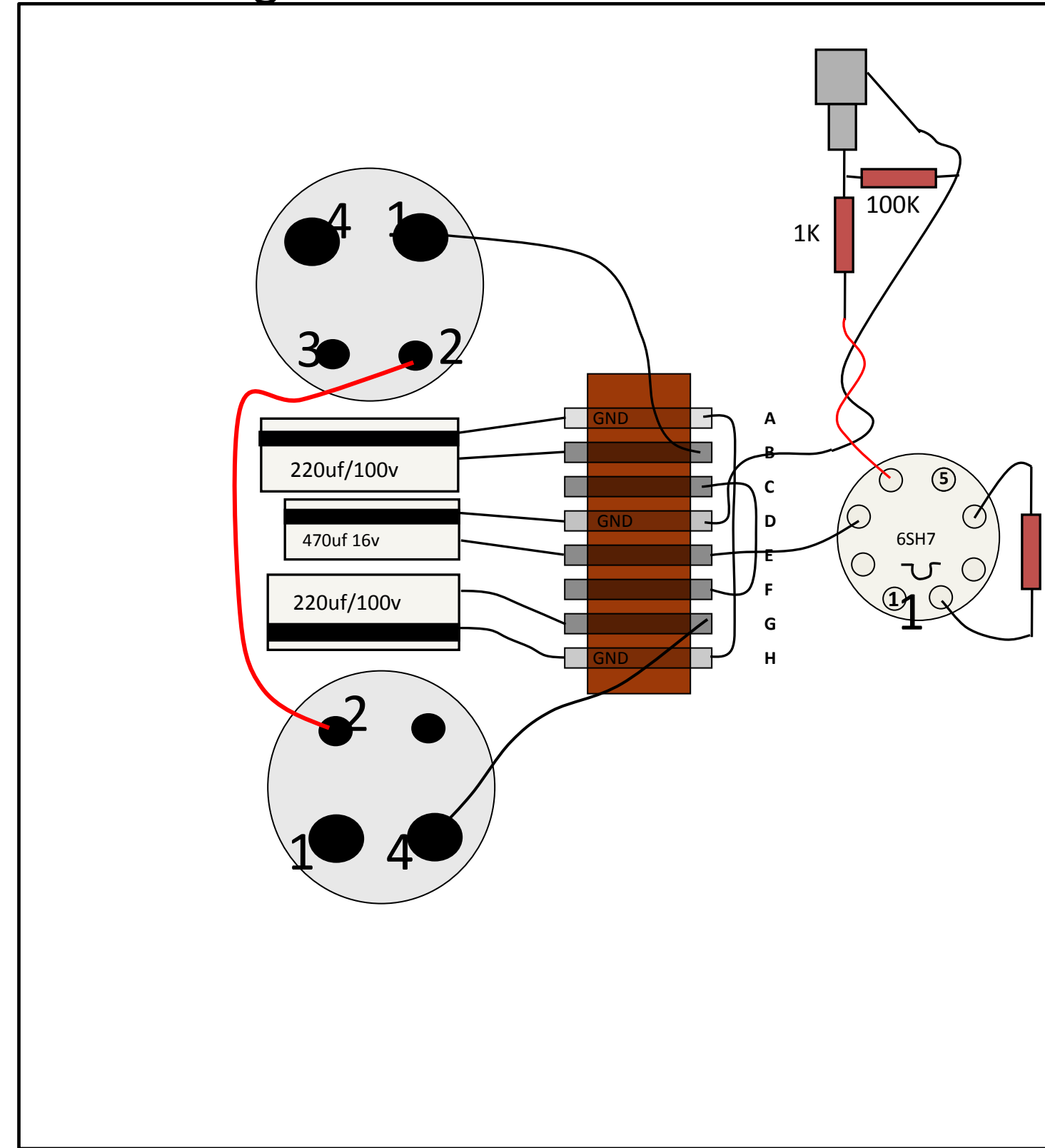

Front Insert Plate Wiring SGND PGND

For clarity purposes the following slides show the insert plate on the LEFT (preceding page graphic) on the right you can follow along as we build up the insert plate with each slide – this way you can refer back to the left drawing to check that the correct connections are being made.

4 x 1K5 resistor 10W

2 x 220uf 100V capacitor
1 x 470uf 16v capacitor

3 x 1K
1 x 330R
1 x 100R

A > > H connection
C >> F connection
E >> pin3 6SH7

G >> pin 1 – 300B TOP
B >> pin 4 – 300B Bottom

Interstage transformer connections

Signal Ground
Power Ground
O/P transformer red >> pin2

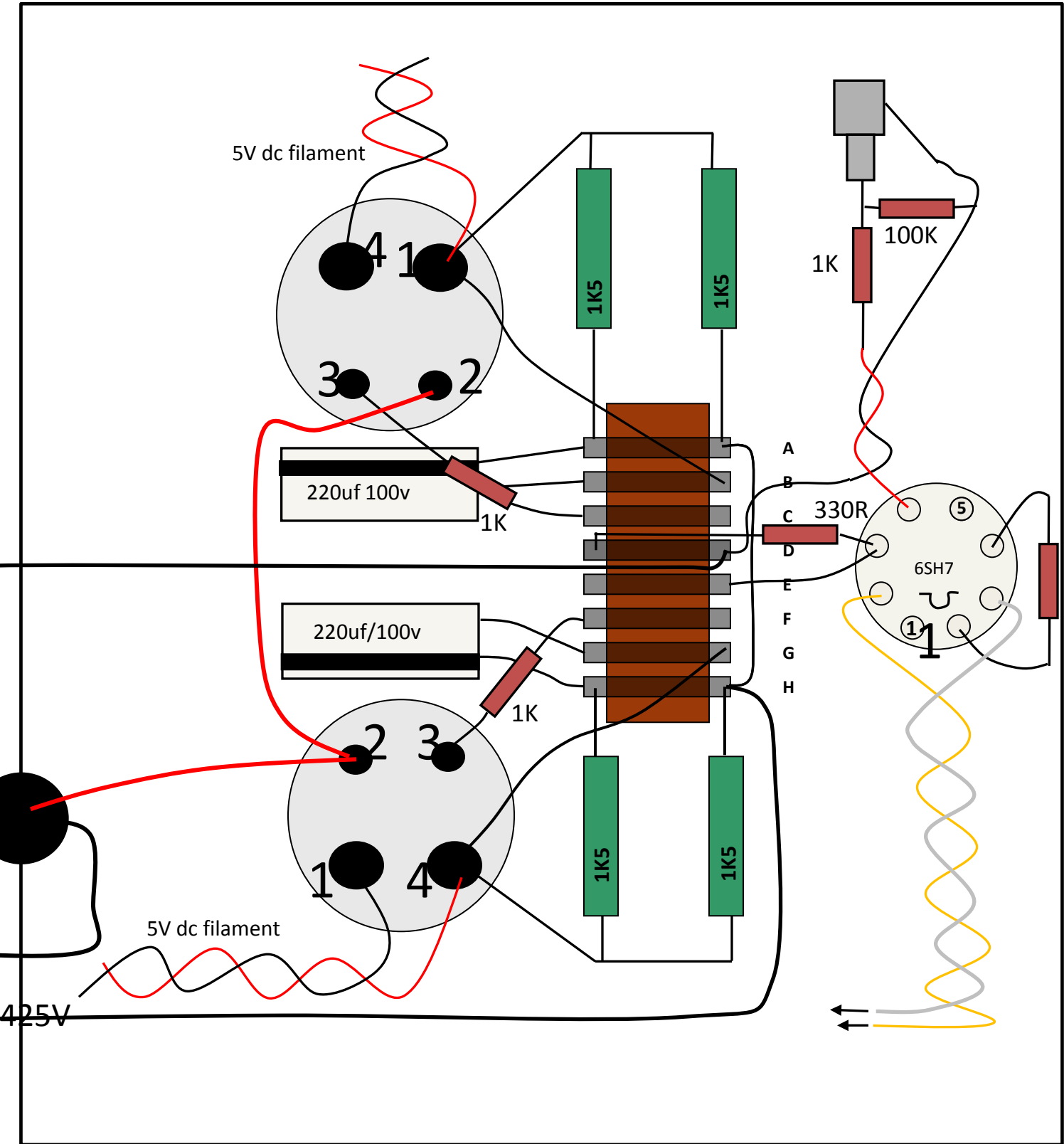
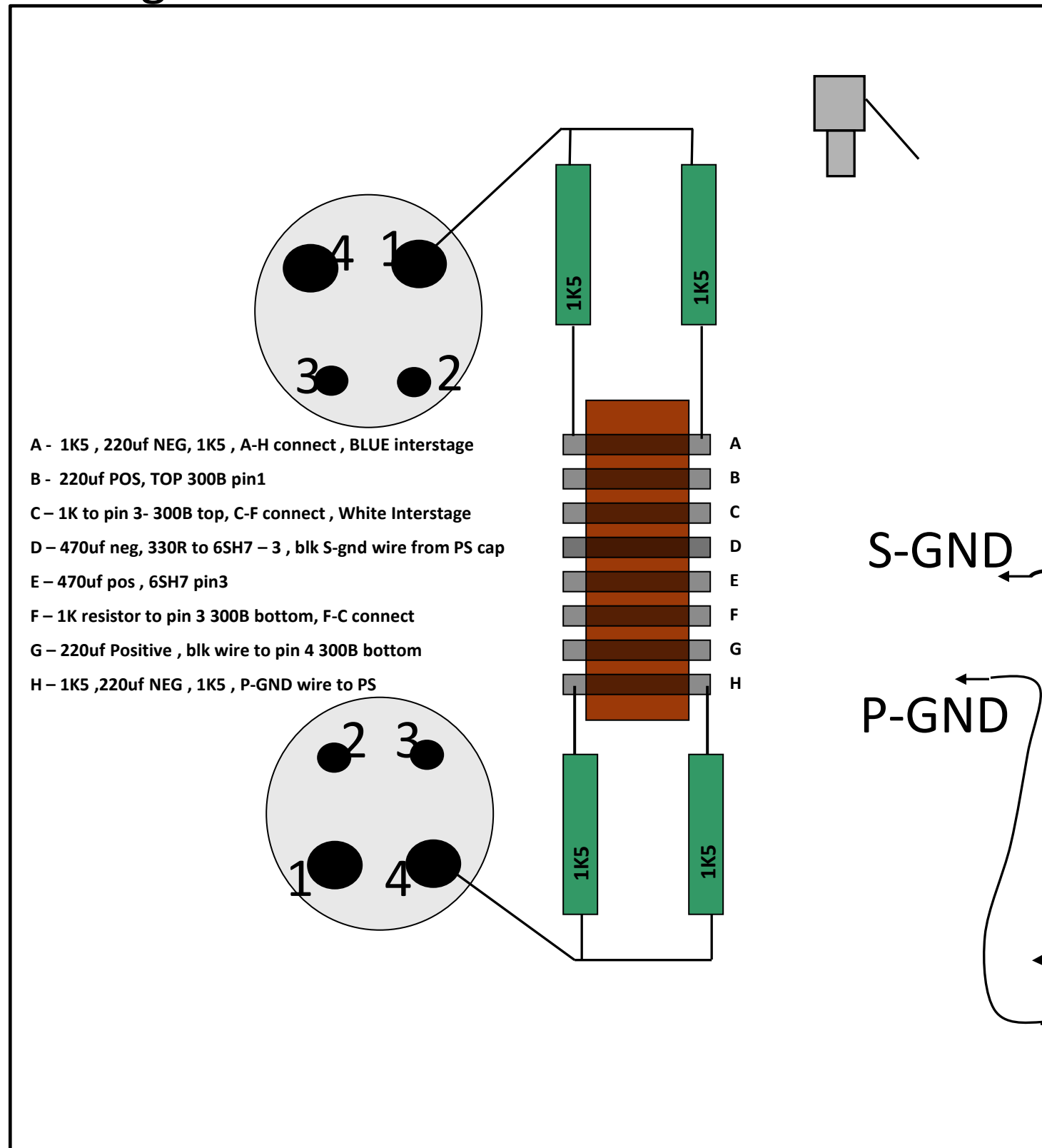

T-195 Mains Interstage MonoBlock Wiring Diagram – Blue/White CT & Insert Plate

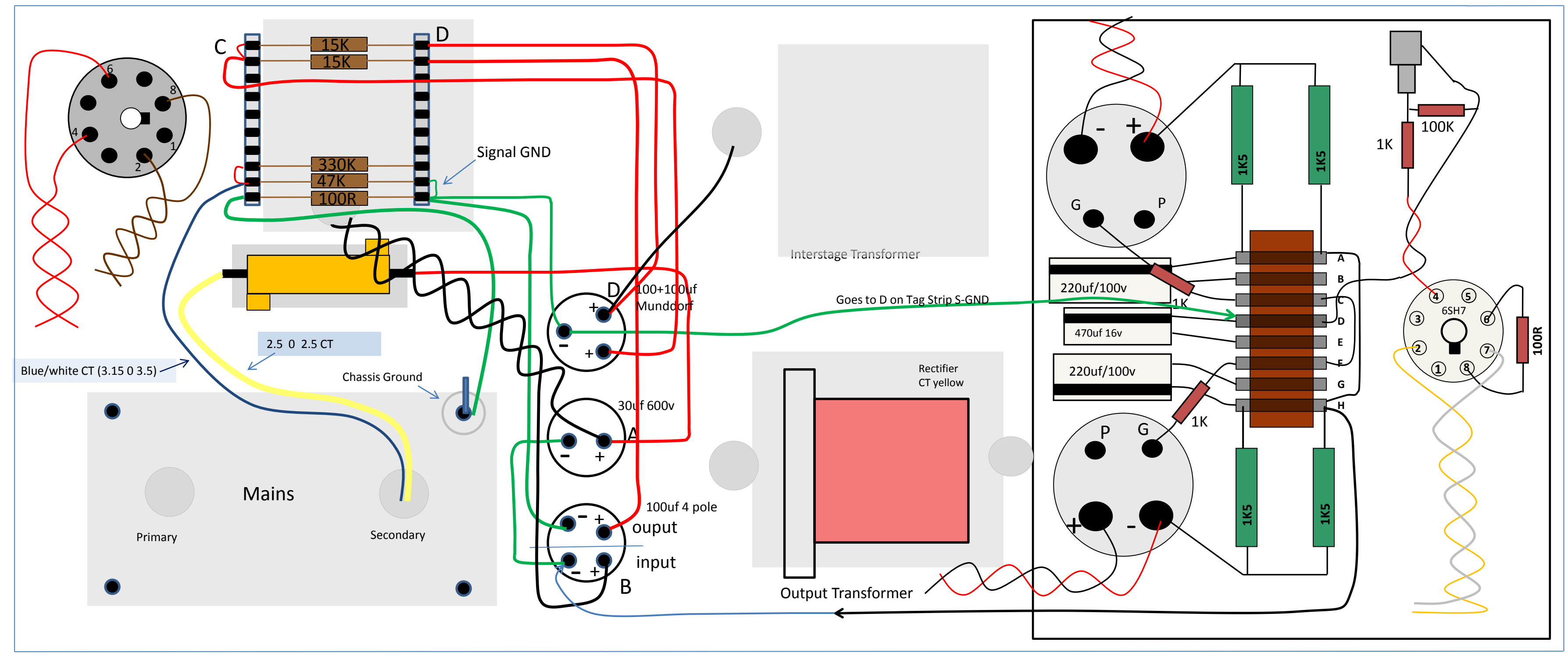

T-195 Mains Interstage MonoBlock Wiring Diagram – Blue/White CT & Insert Plate

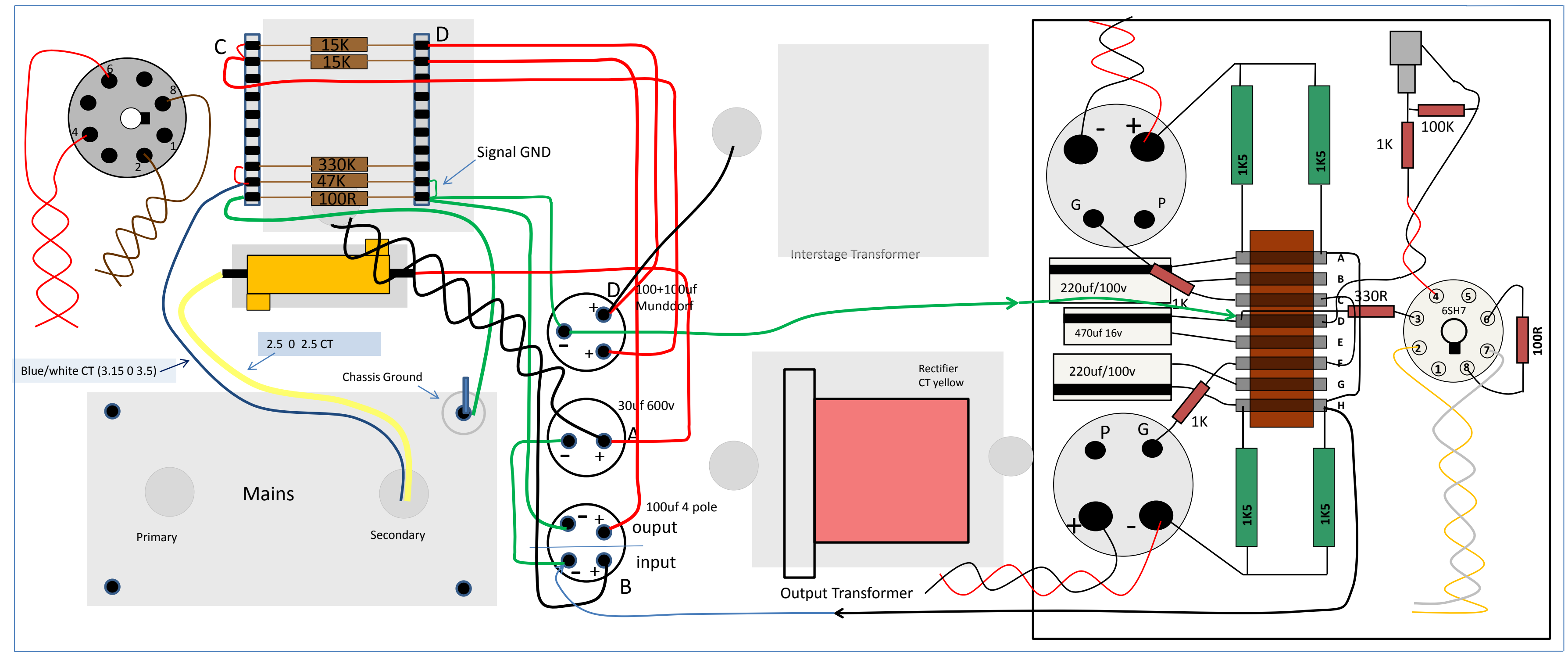

T-195 Mains Interstage MonoBlock Wiring Diagram –Insert Plate final

